

Elevation A

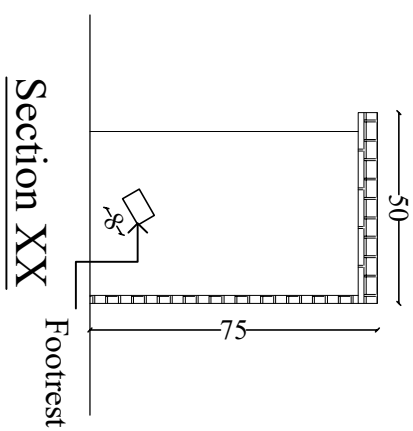
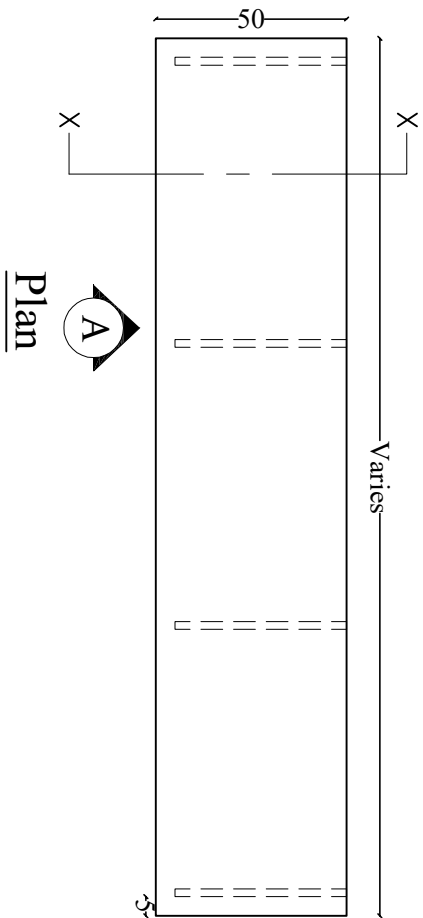

Not to Scale

Drawing :

**Agents
Counter**

Date : 05-03-2020

Client :

**United India Insurance
Company Ltd**

Branch :

Amballoor Branch

Consultants :

M
ANASARA CONSULTANTS

37/37/4, Sreevalsam
Ponoth Road, Kaloor
Cochin-682017, Kerala
Ph: +91- 484 - 27102254
manasara.designs@yahoo.com

All dimensions are in cm unless specified

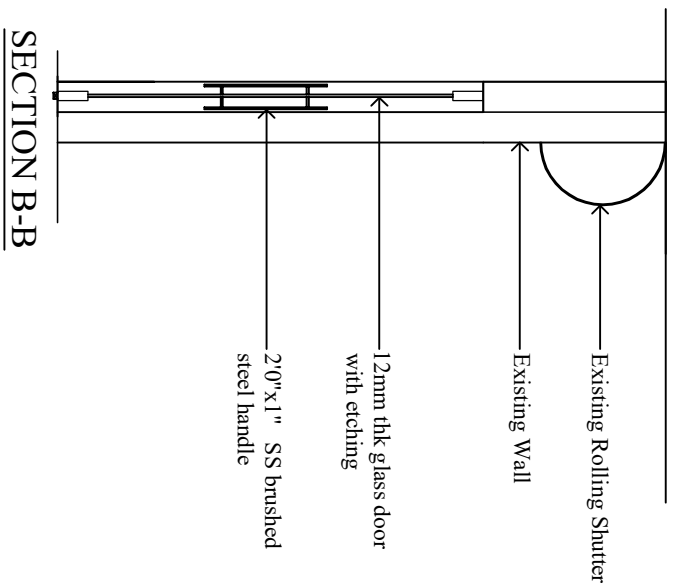
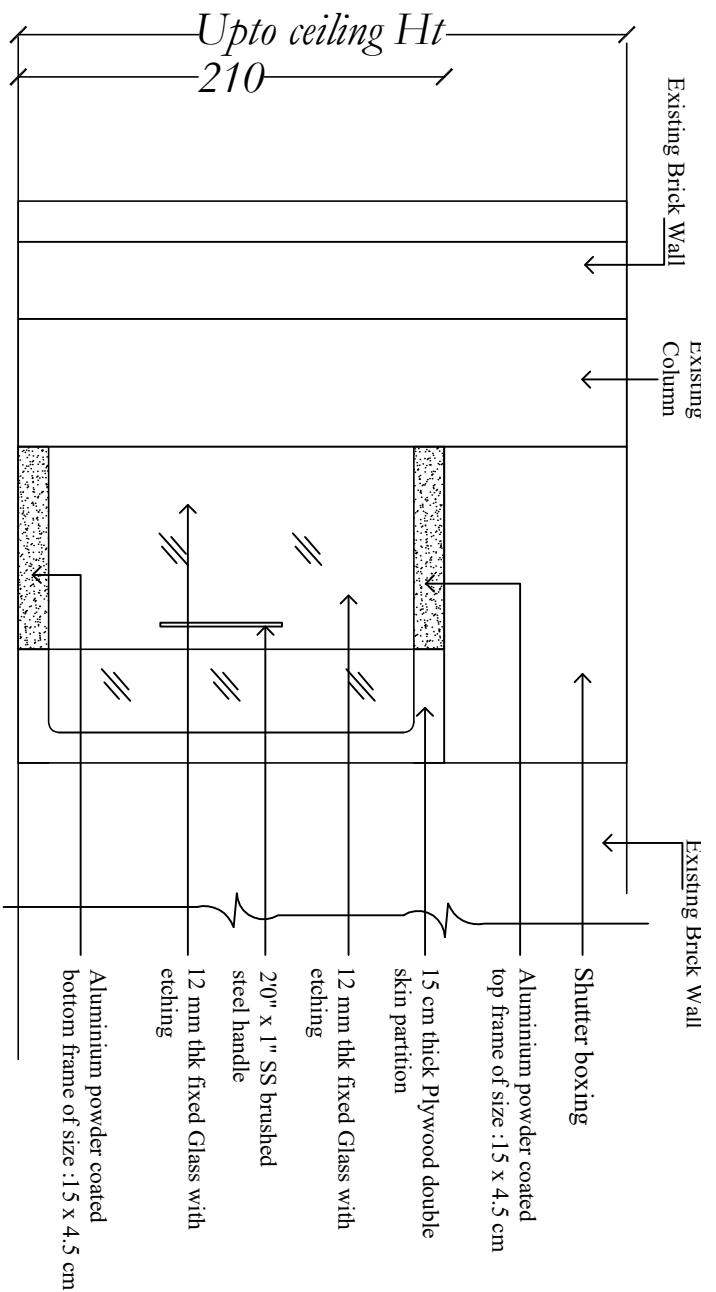

ELEVATION

SECTION B-B

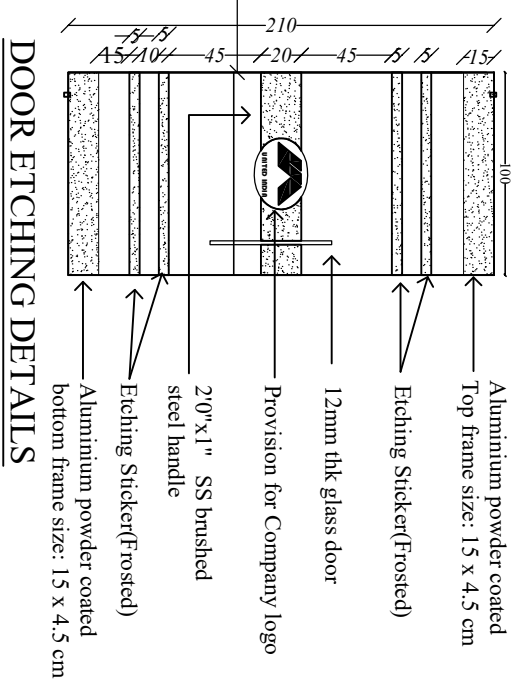
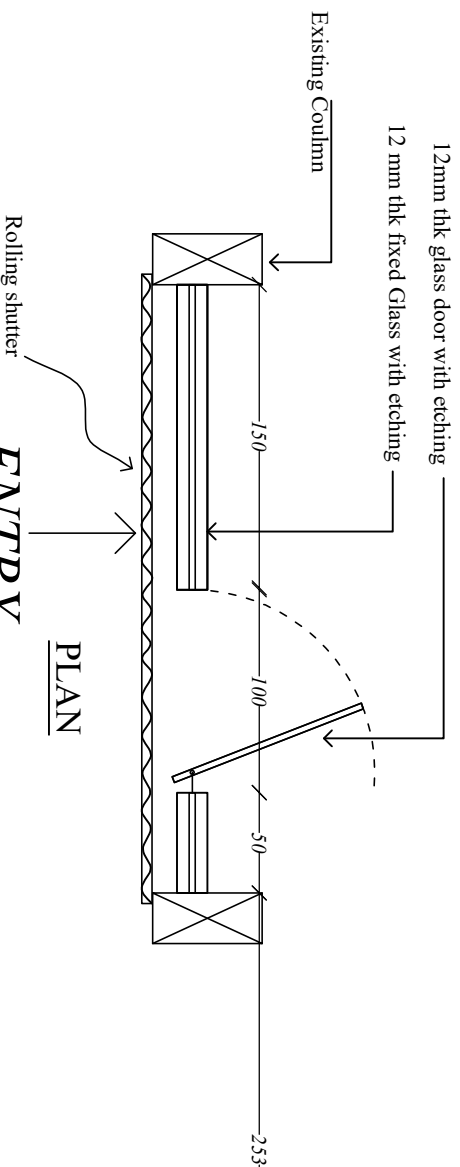

DOOR ETCHING DETAILS

ENTRY

PLAN

Not to Scale

Drawing :

Entrance Door

Date : 05-03-2020

All dimensions are in cm unless specified

Client :

United India Insurance Company Ltd

Branch :

Amballoor Branch

Consultants :

MANASARA CONSULTANTS
 37/37A, Sivareddam
 Pochin Road, Kolar
 Karnataka
 manasaraengg@gmail.com

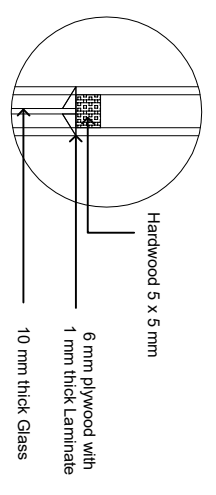
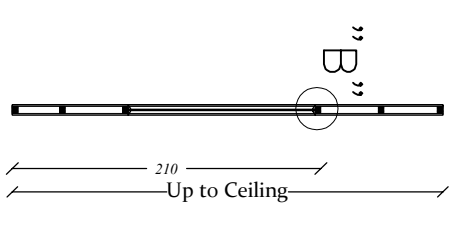
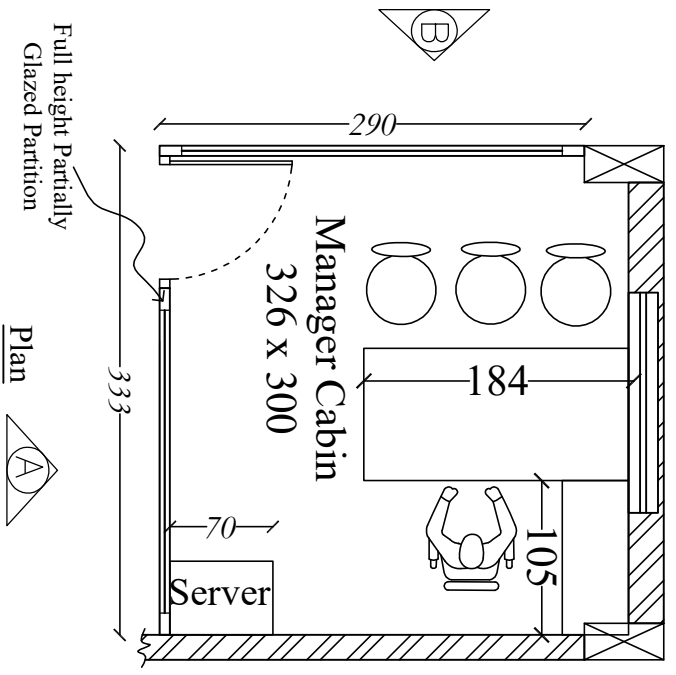
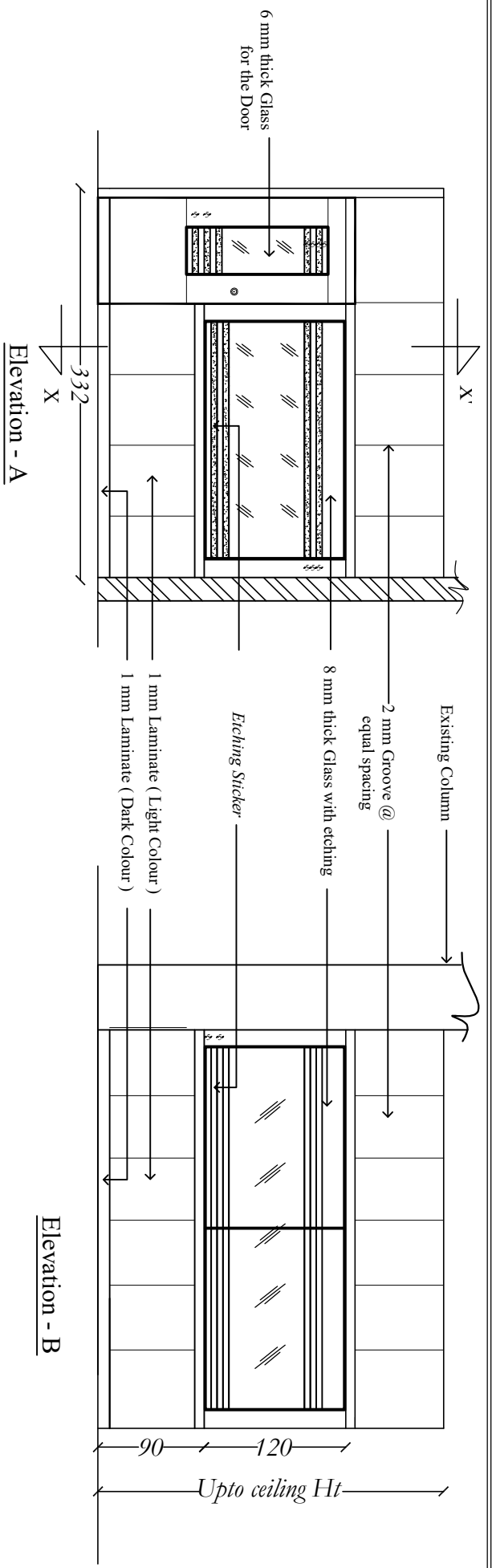

Not to Scale	Drawing	Client : United India Insurance Company Ltd	Consultants :
Date : 05-03-2020	Manager Cabin	Branch : Amballoor Branch	
All dimensions are in cm unless specified			<p>MANASARA CONSULTANTS</p> <p>37/37/4A, Seeladram Poonji Road, Kozhikode Pin - 673 021, Kerala Phone: 94471 74884 manasaraengg@gnafino.com</p>

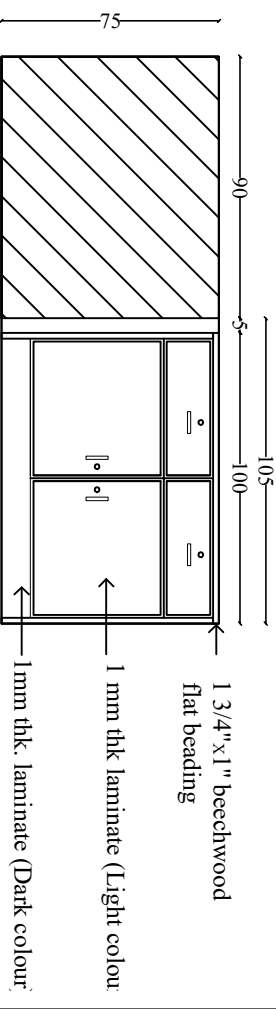
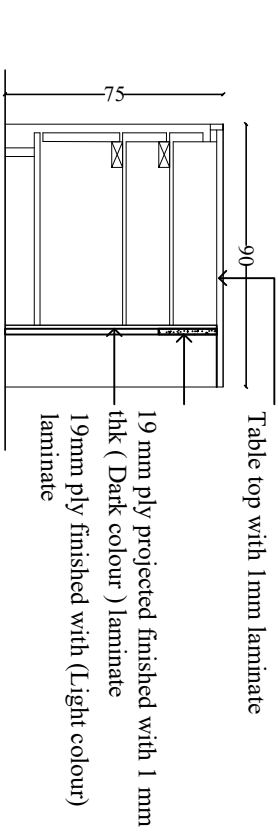
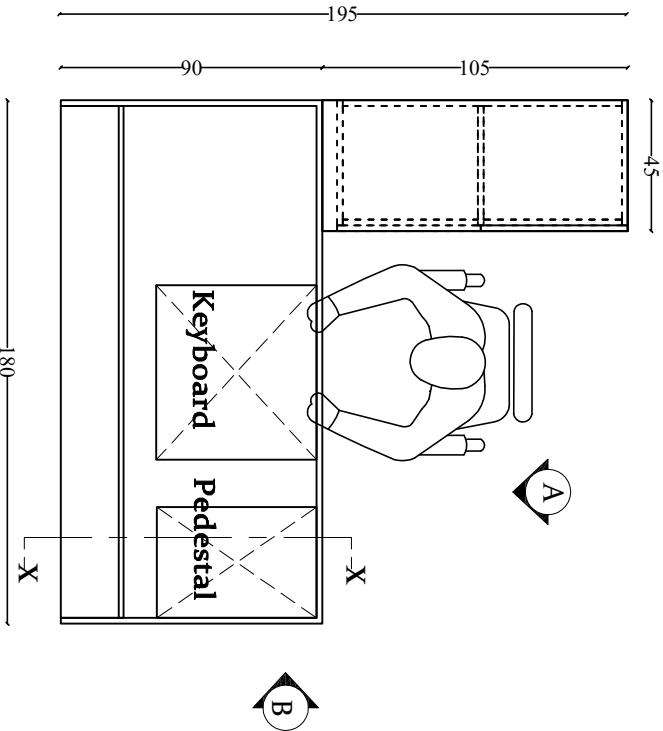
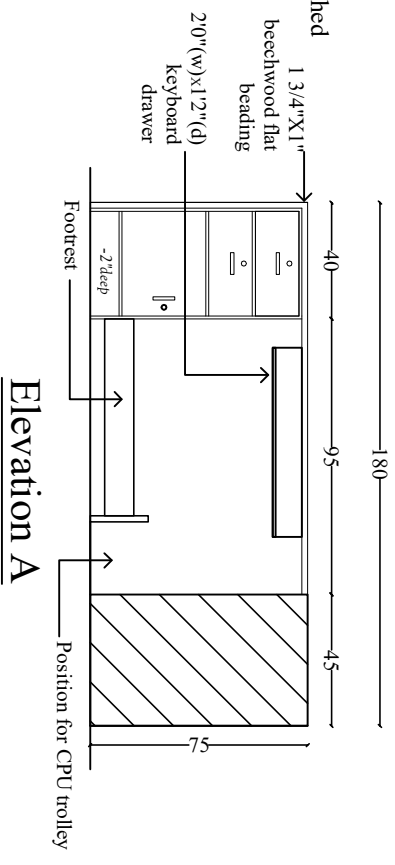
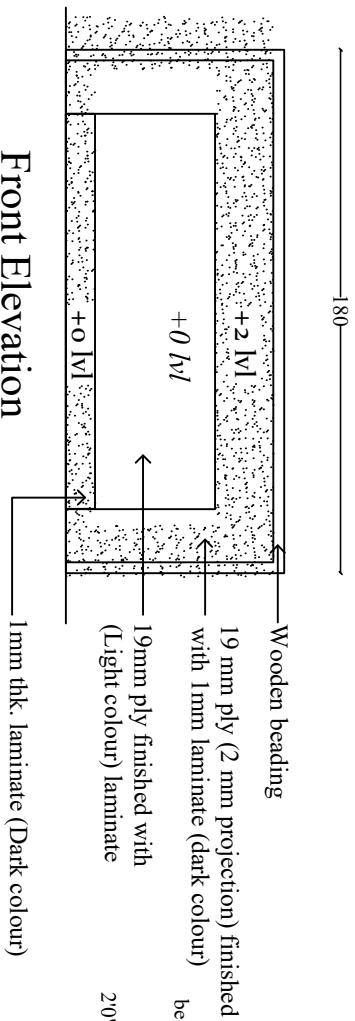

Not to Scale

Drawing :

Manager Table
with side table

Date : 05-03-2020

Client :

United India Insurance Company Ltd

Consultants :

M ANASARA CONSULTANTS

37/374, Seevalisam
Poroth Road Kaloor
Cochin-682017 Kerala
Ph. +91-484-210254
manasaraadesigns@yahoo.com

Branch : *Amballoor Branch*

All dimensions are in cm unless specified

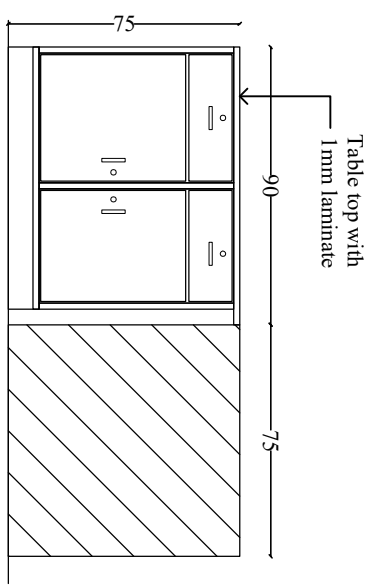
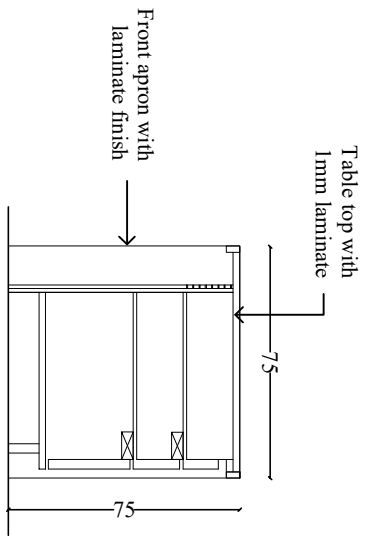
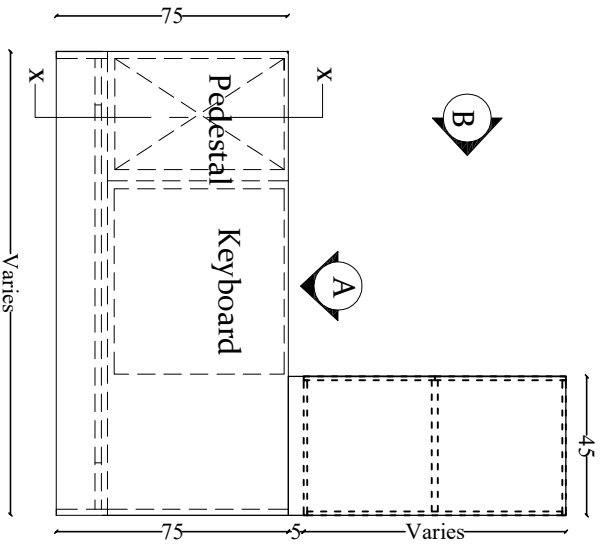
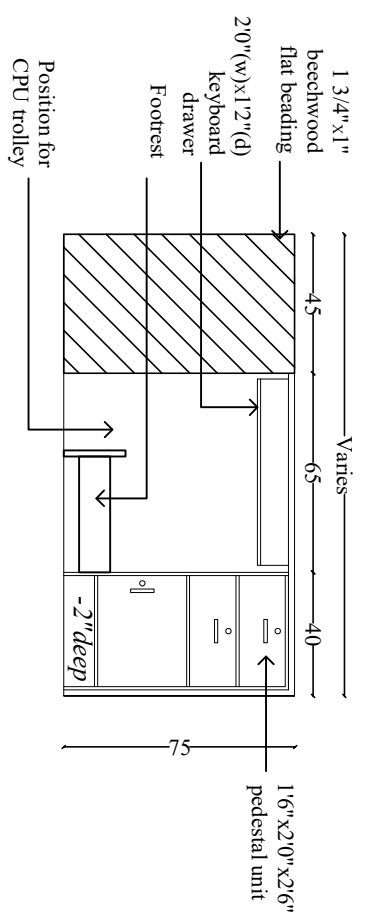
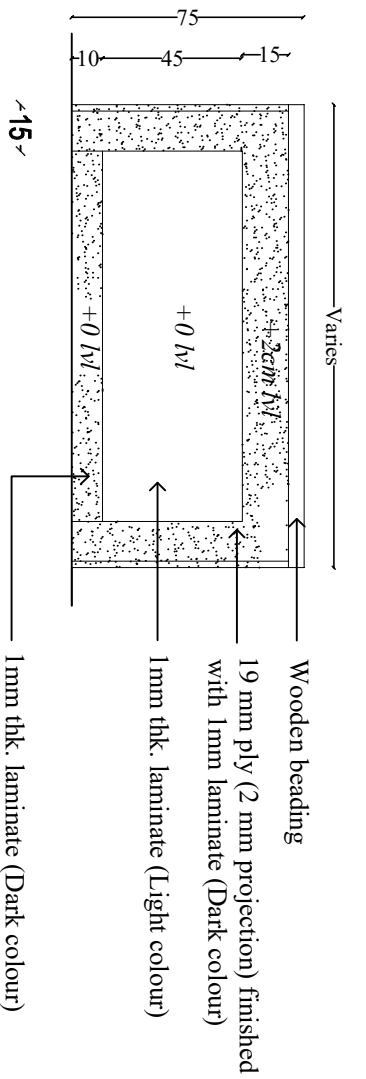

Not to Scale

Drawing: *Officer Table with side table*

Date : 05-03-2020

Client : *United India Insurance Company Ltd*

Branch : *Amballoor Branch*

Consultants :

M ANASARA CONSULTANTS

37/3744, Seevilsam
 Ponoh Road, Kairat
 Cochin-682017, Kerala
 Ph. +91- 484- 210254
 marasaraadessigns@yahoo.com

All dimensions are in cm unless specified

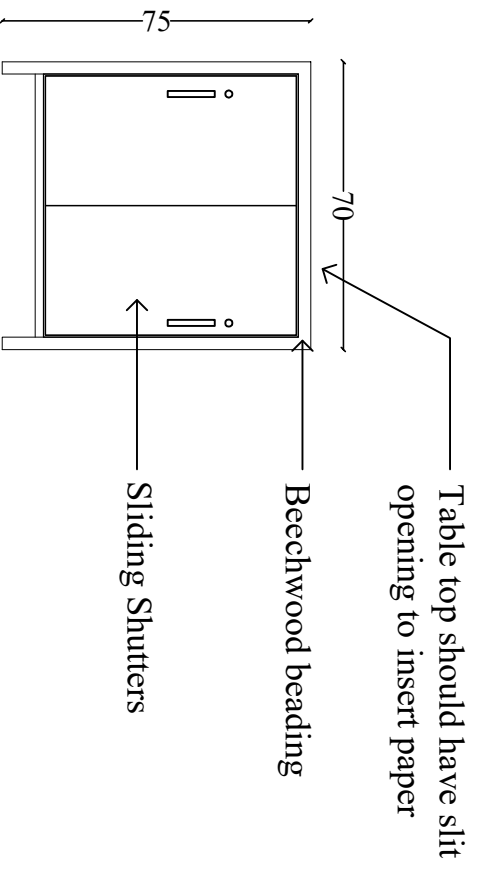

Elevation-A

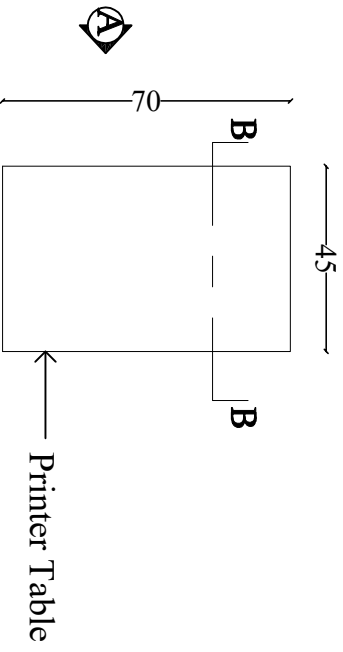

Plan

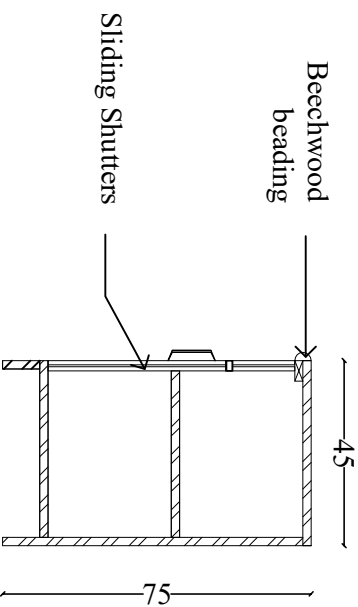

Section BB

<p>Not to Scale</p>	<p>Drawing : <i>Printer Table</i> (For Running counter)</p>	<p>Client : <i>United India Insurance Company Ltd</i></p> <p>Branch : <i>Amballoor Branch</i></p>	<p>Consultants :</p>  <p>ANASARA CONSULTANTS</p> <p>37/3744, Sreevalsam Ponoth Road, Kallor Cochin-682017, Kerala Ph: +91- 484 - 2102254 manasaraesigns@yahoo.com</p>
<p>All dimensions are in cm unless specified</p>			

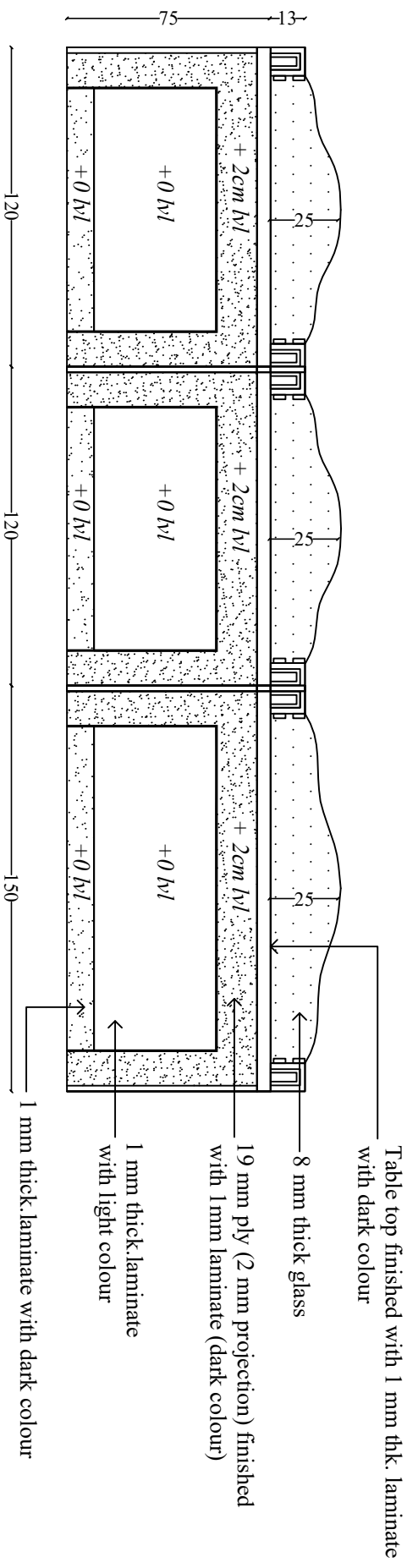

Front Elevation

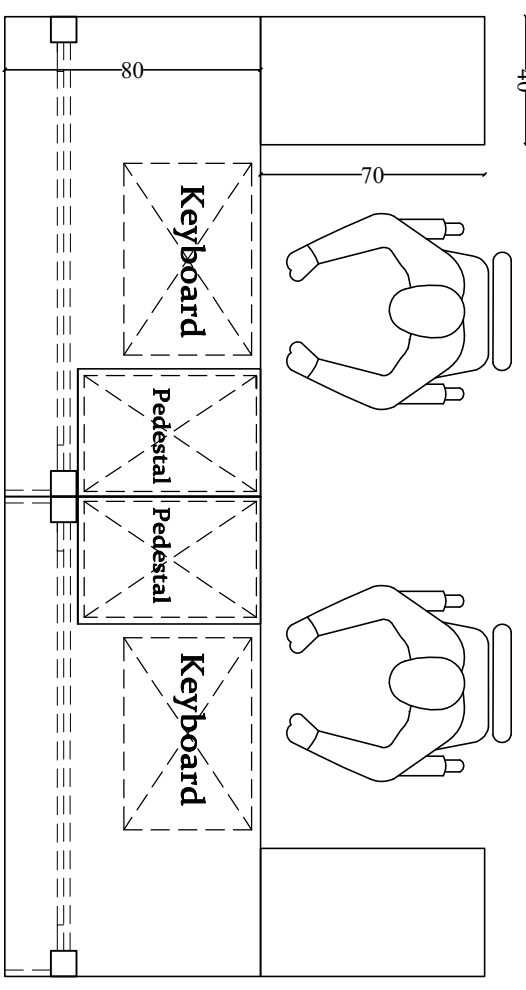

Plan

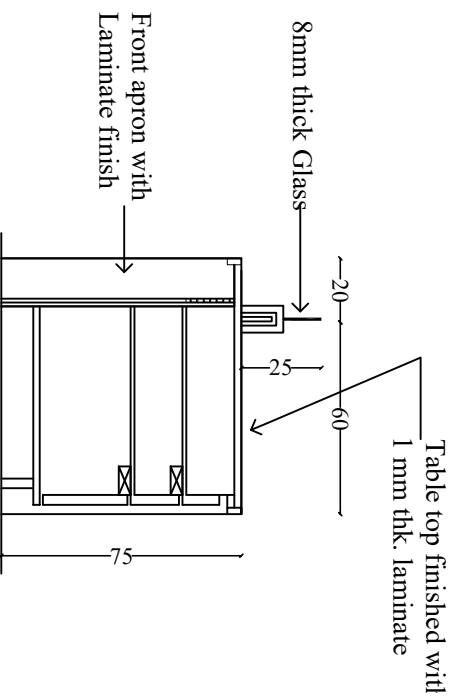

Section XX

Not to Scale

Drawing :

Running Counter Table
(Details)

Date : 05-03-2020

Client :

United India Insurance Company Ltd

Branch :

Amballoor Branch

Consultants :

MANASARA CONSULTANTS

37/374A, Sreevalsam
Ponoth Road, Kalloor
Cochin-682017, Kerala
Ph. +91- 484 - 2102254
manasaradesigns@yahoo.com

All dimensions are in cm unless specified

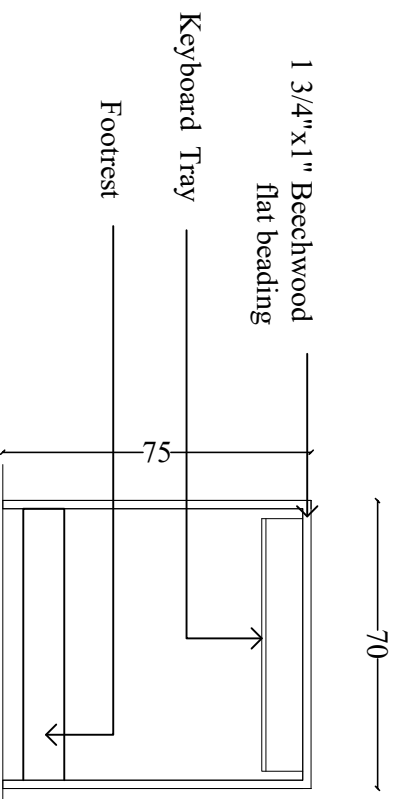

Elevation A

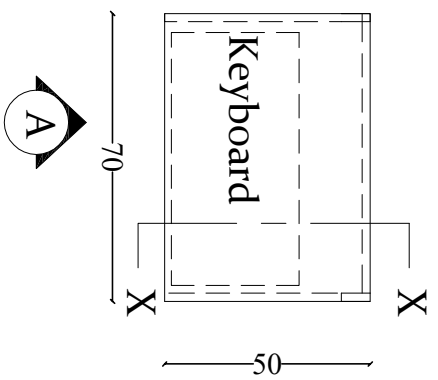

Plan

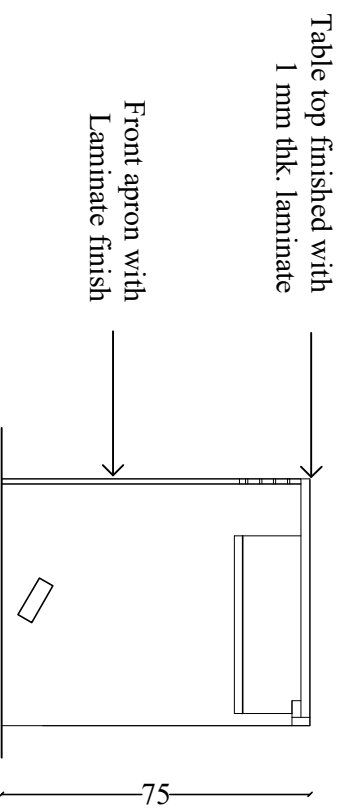

Section XX

<p>Not to Scale</p>	<p>Drawing : <i>Table type -3</i> <i>Server Table</i></p>	<p>Client : <i>United India Insurance</i> <i>Company Ltd</i></p>	<p>Consultants :</p>
<p>Date : 05-03-2020</p>		<p>Branch : <i>Amballoor Branch</i></p>	<p>M ANASARA CONSULTANTS 37/3744, Sreevalsam Ponoth Road, Kallor Cochin-682017, Kerala Ph: +91- 484 - 2102254 manasaraesigns@yahoo.com</p>
<p>All dimensions are in cm unless specified</p>			

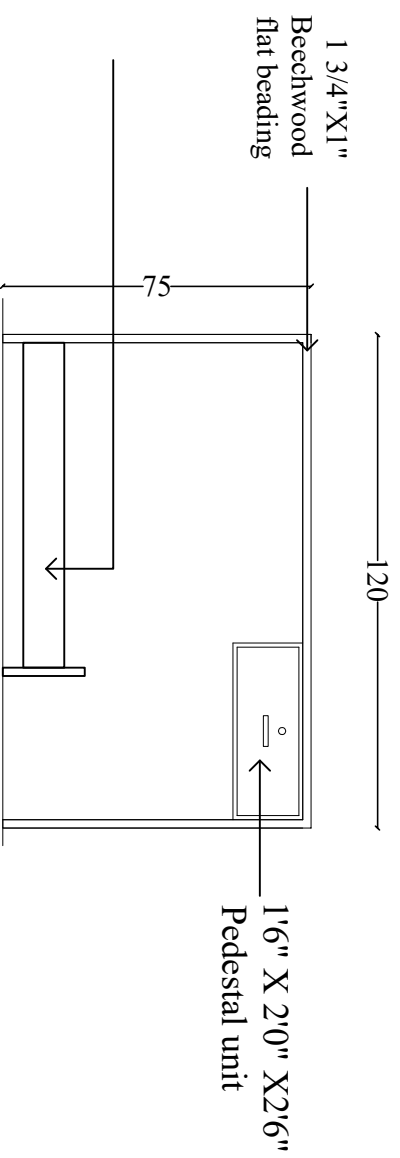

Elevation A

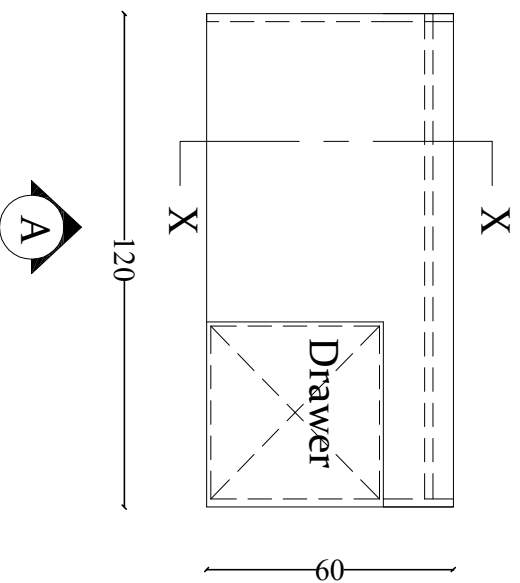

Plan

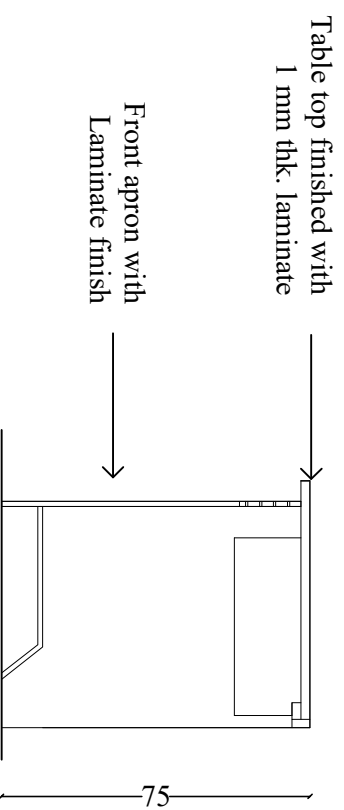

Section XX

<p>Not to Scale</p>	<p>Drawing : <i>Table type - 4 Substaff Table</i></p>	<p>Client : <i>United India Insurance Company Ltd</i></p>	<p>Consultants :</p>
<p>Date : 05-03-2020</p>		<p>Branch : <i>Amballoor Branch</i></p>	<p>M ANASARA CONSULTANTS 37/3744, Sreevalsam Poroth Road, Kallor Cochin-682017, Kerala Ph: +91- 484 - 2102254 manasaraesigns@yahoo.com</p>
<p>All dimensions are in cm unless specified</p>			